

feltdecor[®]
s.line

More than silent

SilentScape Collection

www.feltdecor.eu

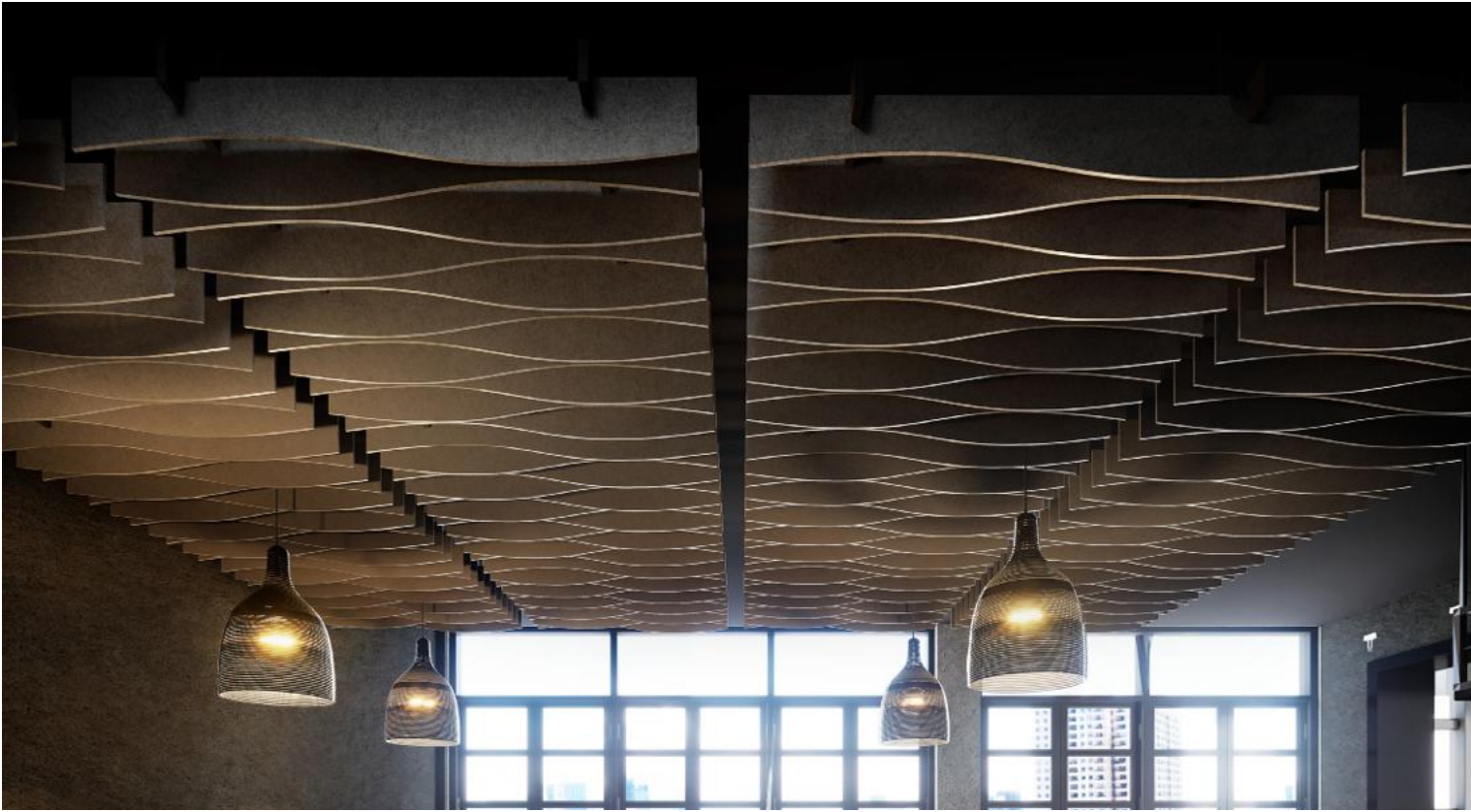

SilentScape - Feltdecor® acoustic suspended systems

SilentScape combines a responsible approach to the environment with modern aesthetics. The suspended modules are made from PET felt recycled from plastic bottles, reducing waste and supporting a closed-loop economy. It's a solution that realistically fits into the idea of sustainable design and conscious material choices.

Functionality that serves comfort. With its advanced acoustic properties, SilentScape effectively reduces reverberation and improves room sound quality. It is a dedicated solution for offices, hotels, commercial spaces and workplaces where acoustic comfort translates into the well-being and efficiency of users.

Design full of freedom and lightness. The modular design of SilentScape allows you to create individual compositions to match the scale and character of the interior. Elements can be freely combined to create unique patterns and configurations. An additional advantage of the collection is its light weight, which facilitates both transportation and quick installation, regardless of the chosen suspension system.

Choose SilentScape - the perfect solution for a space that inspires and delights.

Available colors: According to s.line color chart

Minimum order: One module

Mounting method: Screwed directly to the ceiling, suspended on cables

Installation method: Perforation

Edge finishing: Straight cut

Module dimension: 1200x1200 mm, 2400x1200 mm

3D models: Available from distributor

Primary color palette

feltdecor®
s.line

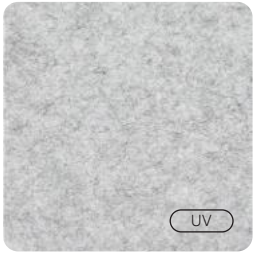

FD10 / Wolf Grey

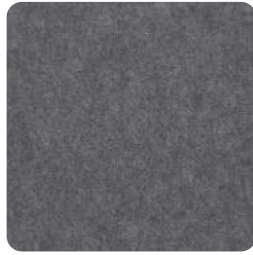

FD80 / Ash Grey



FD26 / Moonstone Grey



FD27 / Raven Black



FD25 / Onyx Grey



FD39 / Fallow Grey

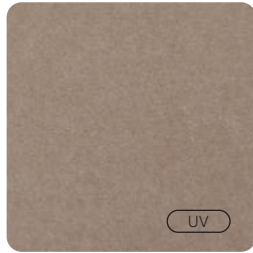

FD06 / Desert Sand



FD05 / Sandy Beige



FD66 / Burly Wood

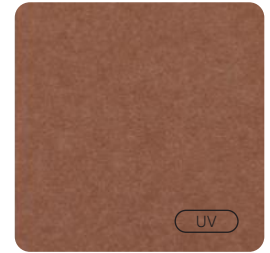

FD51 / Peru Brown

Thickness: +/- 9 mm | **Density:** 2000 g/m² | **Composition:** 100% PET polyester (partially recycled)
Sound absorption class: PN-EN ISO11654 $\alpha_w = 0,25$ for the product unassembled
Fire classification: PN-EN 13501-1:2018 B-s1, d0 for all product applications

Slight differences in color and texture may occur with multiple orders.

Synthetic felt is a heterogeneous mixture of polyester fibers, so that slight differences in color are a natural characteristic of the material and are no reason for complaint.

The colors shown may vary depending on the characteristics of your screen - we recommend that you visit your dealer to make sure of your final color choice.

www.feltdecor.eu

Color palette

Colors on request s.line 9mm - ask for availability



FD08 / Umber Brown



FD49 / Sunny Yellow



FD03 / Tangerine



FD17 / Poppy Red



FD18 / Crimson Mist



FD19 / Purple Rain



FD92 / Galactic Indigo



FD23 / Deep Sky Blue



FD22 / Azure Blue



FD63 / Spring Sky



FD61 / Emerald Aurora



FD72 / Peridot Green



FD13 / Spring Green



FD55 / Fresh Grass



FD04 / Moonlight

Thickness: +/- 9 mm | **Density:** 2000 g/m² | **Composition:** 100% PET polyester (partially recycled)
Sound absorption class: PN-EN ISO11654 $\alpha_w = 0,25$ for the product unassembled
Fire classification: PN-EN 13501-1:2018 B-s1, d0 for all product applications

Slight differences in color and texture may occur with multiple orders.

Synthetic felt is a heterogeneous mixture of polyester fibers, so that slight differences in color are a natural characteristic of the material and are no reason for complaint.

The colors shown may vary depending on the characteristics of your screen - we recommend that you visit your dealer to make sure of your final color choice.

Color palette - UV printing

Only on FD05 / FD06 / FD10 / FD66



Classic Woodland



Beech Velvet



Dark Board



Darkwood Whispers



Driftwood Echo



Elder Wood



Oak Impressions



Rustic Grove



Vintage Timber



Walnut Heartwood



Woodland Charm



Woodland Harmony



Old Rust



Vintage Rust



Concrete Mirage

Thickness: +/- 9 mm | **Density:** 2000 g/m² | **Composition:** 100% PET polyester (partially recycled)
Sound absorption class: PN-EN ISO11654 $\alpha_w = 0,25$ for the product unassembled
Fire classification: PN-EN 13501-1:2018 B-s1, d0 for all product applications

Slight differences in color and texture may occur with multiple orders.

Synthetic felt is a heterogeneous mixture of polyester fibers, so that slight differences in color are a natural characteristic of the material and are no reason for complaint.

The colors shown may vary depending on the characteristics of your screen - we recommend that you visit your dealer to make sure of your final color choice.

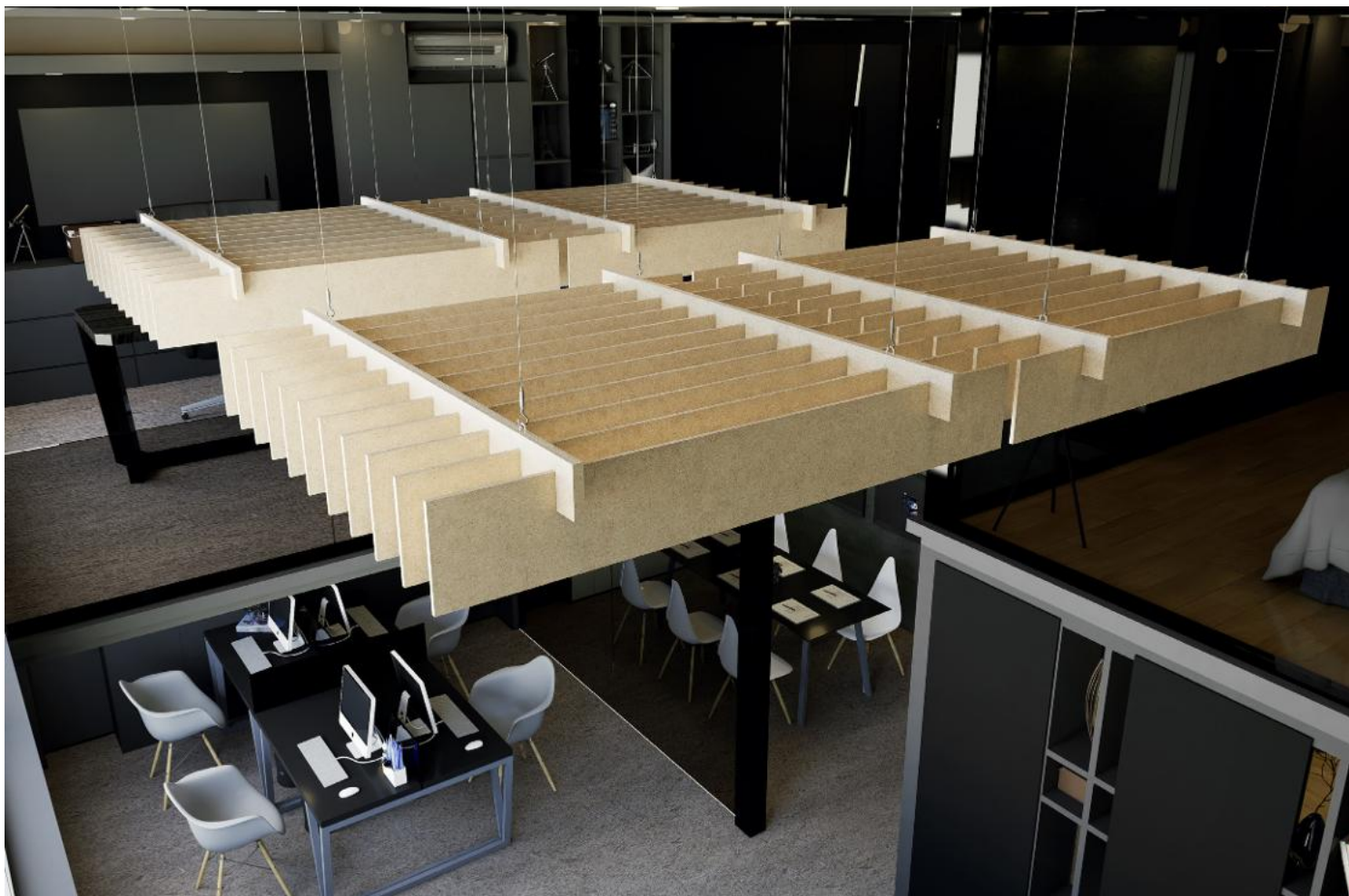

SilentLink_120

Dimensions:

SilentLink_120 A - 1200 x 1200 x 200 mm

SilentLink_120 B - 1200 x 1200 x 200 mm

SilentLink_240

Dimensions:

SilentLink_240 A - 2400 x 1200 x 200 mm

SilentLink_240 B - 2400 x 1200 x 200 mm

Material thickness: 9mm

Material density: 2000 g/m²

Installation method: Screwed directly to the surface, suspended on cables

Packing: Cartons with dimensions of 40x11x123 cm, weight 6 kg or 40x11x243, weight 12 kg

Module type: Razorblade

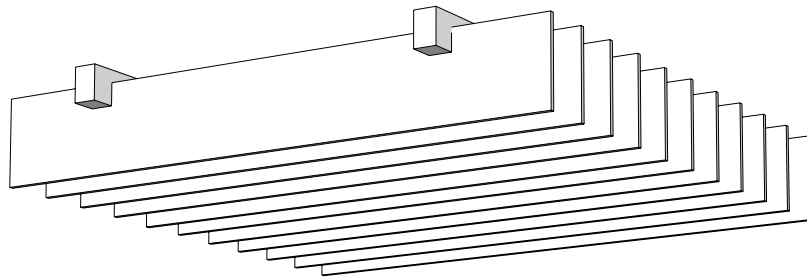

SilentLink_120 A

Wide mounting rail - 2 pieces

*Mounting - directly to the surface or suspended on cables.

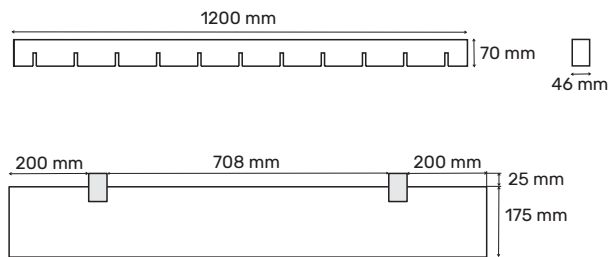

SilentLink_120 B

Narrow mounting rail - 2 pieces

*mounting - suspension on cables

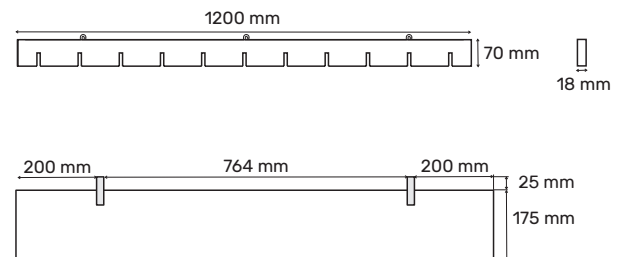

The suspended system consists of 11 baffles and 2 felt-lined mounting rails - narrow or wide.

Optional sling systems are available to suit individual installation requirements.

View from above

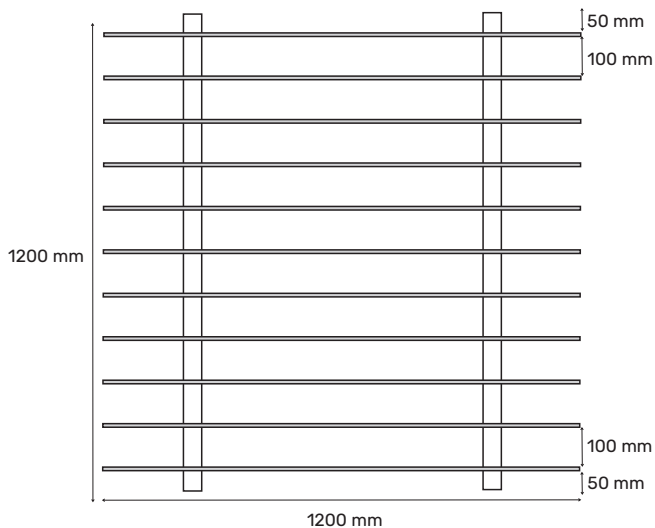

Cross section

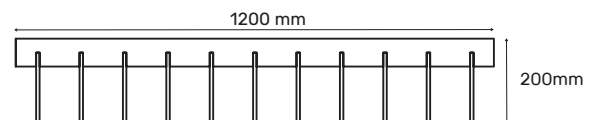

Baffle

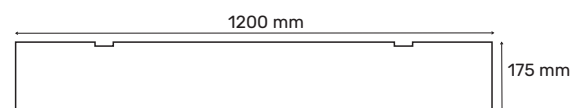



WhisperWave_120

Dimensions:

WhisperWave_120 A - 1200 x 1200 x 218 mm

WhisperWave_120 B - 1200 x 1200 x 218 mm

WhisperWave_240

Dimensions:

WhisperWave_240 A - 2400 x 1200 x 218 mm

WhisperWave_240 B - 2400 x 1200 x 218 mm

Material thickness: 9mm

Material density: 2000 g/m²

Installation method: Screwed directly to the surface, suspended on cables

Packing: Cartons with dimensions of 40x11x123 cm, weight 6 kg or 40x11x243, weight 12 kg

Module type: Razorblade

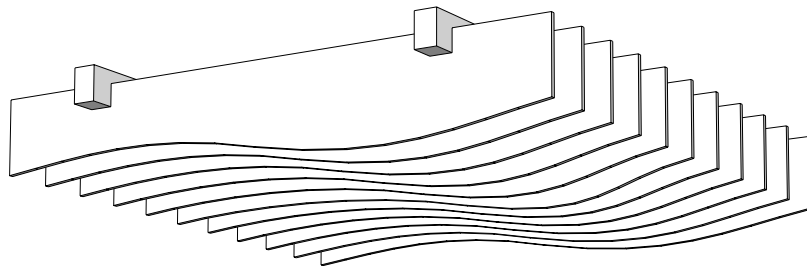

WhisperWave_120 A

Wide mounting rail - 2 pieces

*Mounting - directly to the surface or suspended on cables.

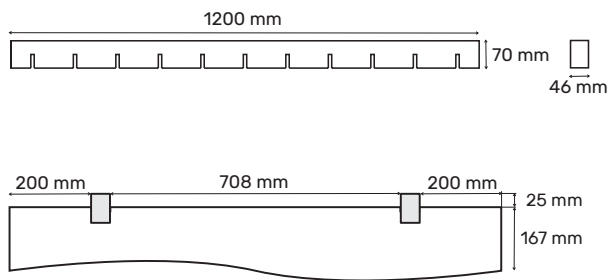

WhisperWave_120 B

Narrow mounting rail - 2 pieces

*mounting - suspension on cables

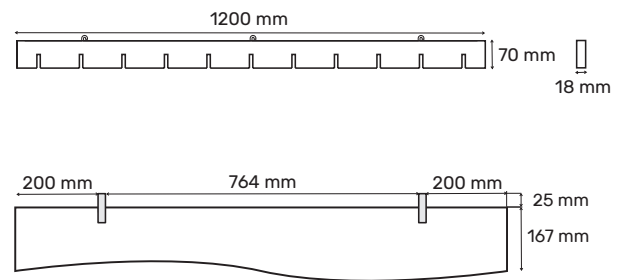

The suspended system consists of 11 baffles and 2 felt-lined mounting rails - narrow or wide.

Optional sling systems are available to suit individual installation requirements.

View from above

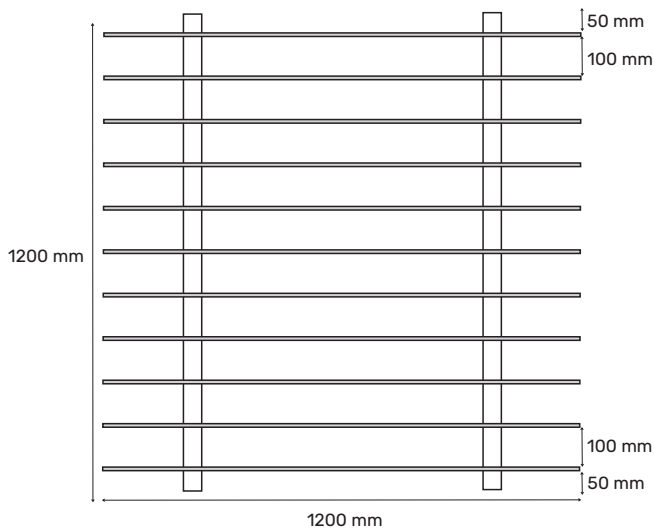

Cross section



Baffle

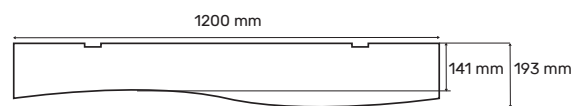



FlexiTone_120

Dimensions:

FlexiTone_120 A - 1200 x 1200 x 210 mm

FlexiTone_120 B - 1200 x 1200 x 210 mm

FlexiTone_240

Dimensions:

FlexiTone_240 A - 2400 x 1200 x 210 mm

FlexiTone_240 B - 2400 x 1200 x 210 mm

Material thickness: 9mm

Material density: 2000 g/m²

Installation method: Screwed directly to the surface, suspended on cables

Packing: Cartons with dimensions of 40x11x123 cm, weight 6 kg or 40x11x243, weight 12 kg

Module type: Razorblade

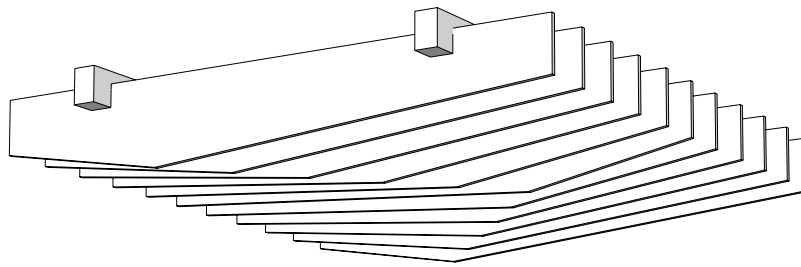

FlexiTone_120 A

Wide mounting rail - 2 pieces

*Mounting - directly to the surface or suspended on cables.

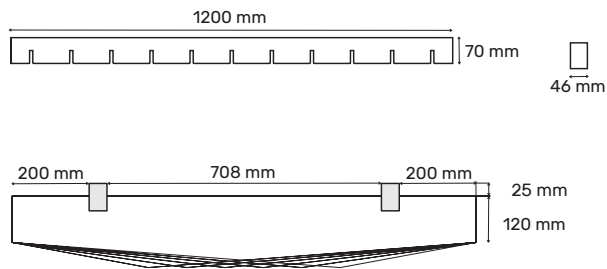

FlexiTone_120 B

Narrow mounting rail - 2 pieces

*mounting - suspension on cables

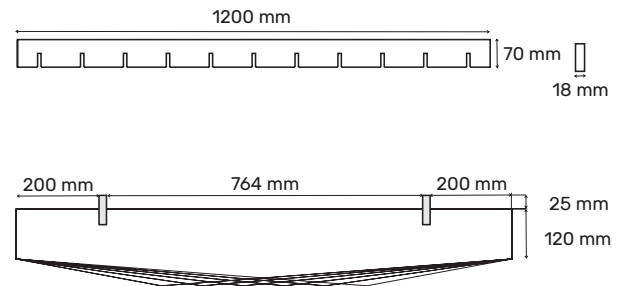

The suspended system consists of 11 baffles and 2 felt-lined mounting rails - narrow or wide.

Optional sling systems are available to suit individual installation requirements.

Cross section

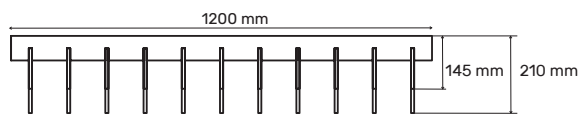

Baffle

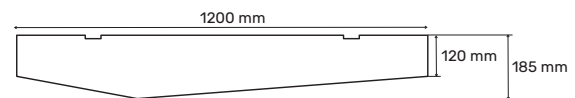

View from above

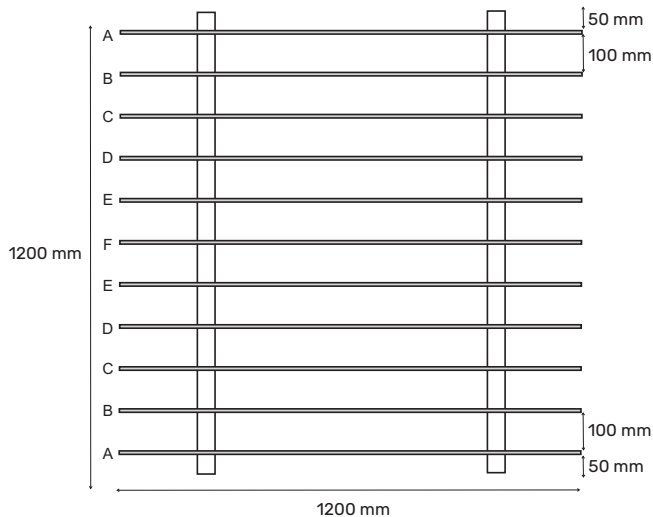
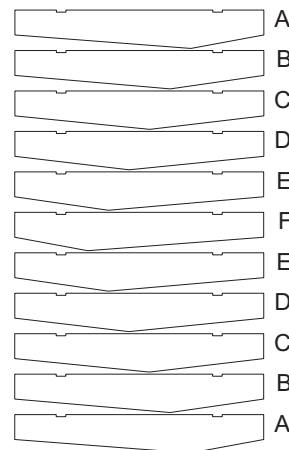

Diagram of how to plug in the baffles





HarmonyGrid_120 / HarmonyGrid_120-F

Dimensions:

HarmonyGrid_120 A / A-F - 1200 x 1200 x 125 mm

HarmonyGrid_120 B / B-F - 1200 x 1200 x 125 mm

HarmonyGrid_240 / HarmonyGrid_240-F

Dimensions:

HarmonyGrid_240 A / A-F - 2400 x 1200 x 125 mm

HarmonyGrid_240 B / B-F - 2400 x 1200 x 125 mm

Material thickness: 9mm

Material density: 2000 g/m²

Installation method: Screwed directly to the surface, suspended on cables

Packing: Cartons with dimensions of 40x11x123 cm, weight 6 kg or 40x11x243, weight 12 kg

Module type: Panel

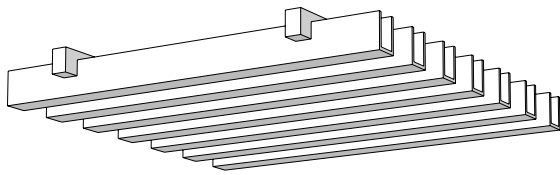

HarmonyGrid_120 A / HarmonyGrid_120 B
1200 x 1200 x 125 mm

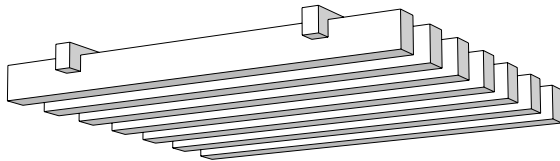
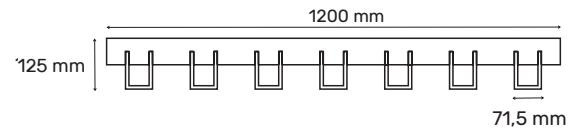

HarmonyGrid_120 A-F / HarmonyGrid_120 B-F
1200 x 1200 x 125 mm

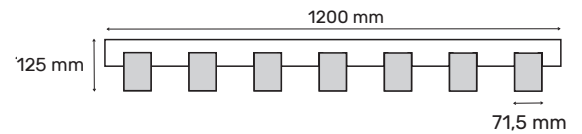

HarmonyGrid_120_A / A-F

Wide mounting rail - 2 pieces

*Mounting - directly to the surface or suspended on cables.

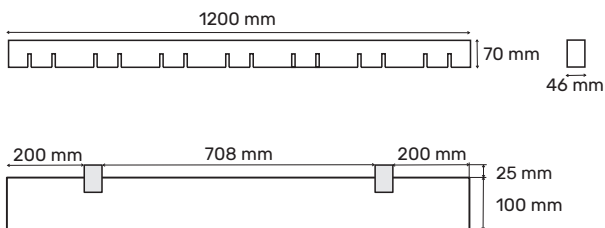

HarmonyGrid_120_B / A-F

Narrow mounting rail - 2 pieces

*mounting - suspension on cables

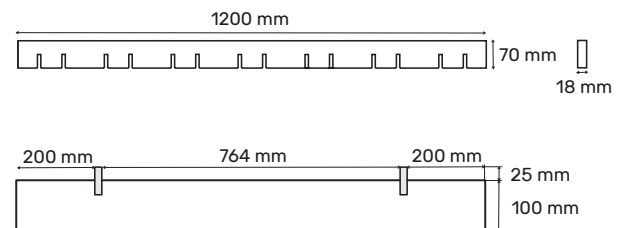

The suspended system consists of 7 baffles and 2 felt-lined mounting rails - narrow or wide.

Optional sling systems are available to suit individual installation requirements.

View from above

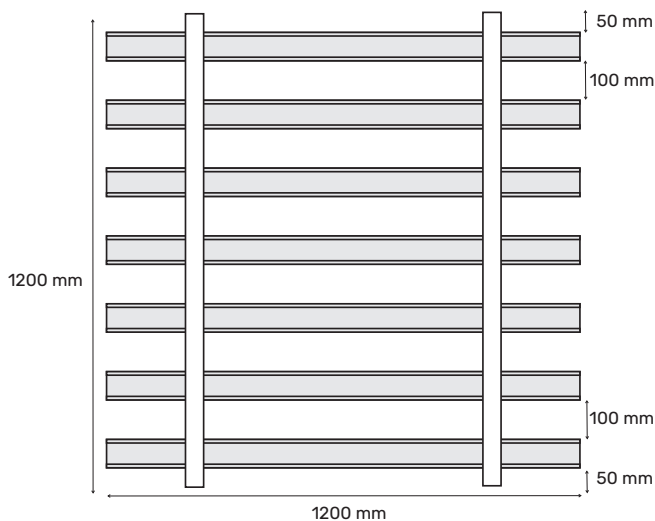

Baffle

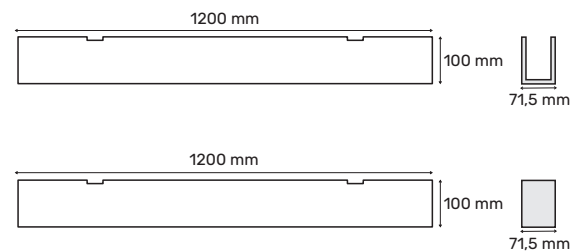

With the HarmonyGrid_F version, you need to glue the caps.



SilentTune_120 / SilentTune_120-F

Dimensions:

SilentTune_120 A / A-F - 1200 x 1200 x 125 mm

SilentTune_120 B / B-F - 1200 x 1200 x 125 mm

SilentTune_240 / SilentTune_240-F

Dimensions:

SilentTune_240 A / A-F - 2400 x 1200 x 125 mm

SilentTune_240 B / B-F - 2400 x 1200 x 125 mm

Material thickness: 9mm

Material density: 2000 g/m²

Installation method: Screwed directly to the surface, suspended on cables

Packing: Cartons with dimensions of 40x11x123 cm, weight 6 kg or 40x11x243, weight 12 kg

Module type: Panel

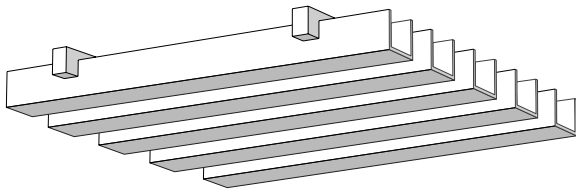

SilentTune_120 A / SilentTune_120 B
1200 x 1200 x 125 mm

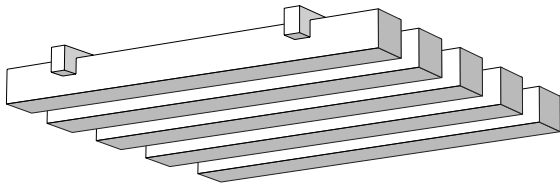
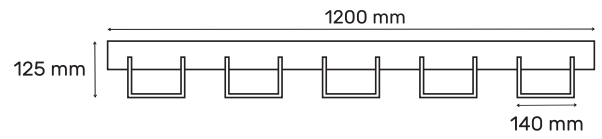

SilentTune_120 A-F / SilentTune_120 B-F
1200 x 1200 x 125 mm

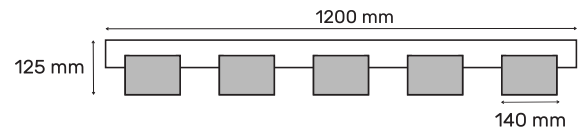

SilentTune_120_A / A-F

Wide mounting rail - 2 pieces

*Mounting - directly to the surface or suspended on cables.

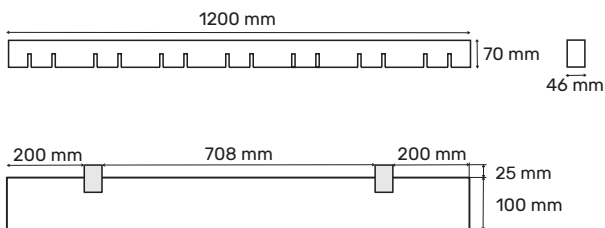

SilentTune_120_B / B-F

Narrow mounting rail - 2 pieces

*mounting - suspension on cables

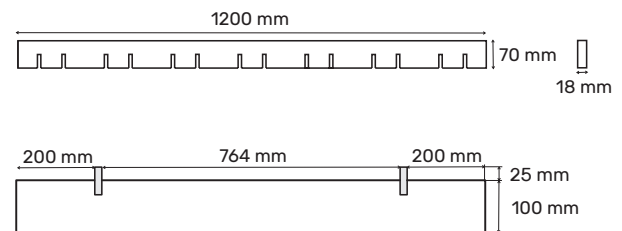

The suspended system consists of 5 baffles and 2 felt-lined mounting rails - narrow or wide.

Optional sling systems are available to suit individual installation requirements.

View from above

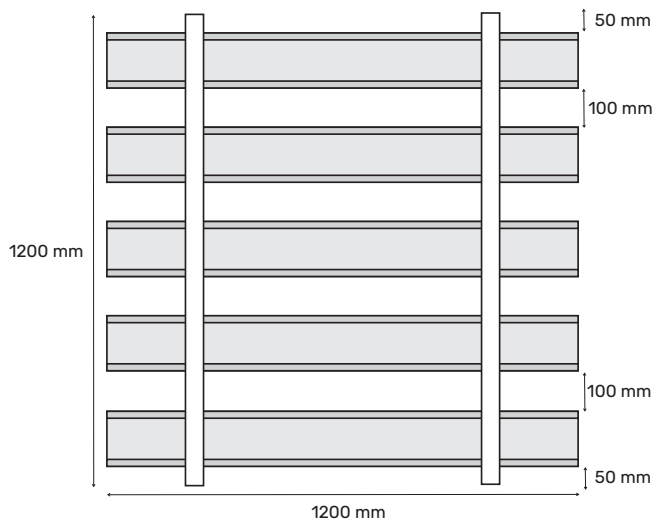

Baffle

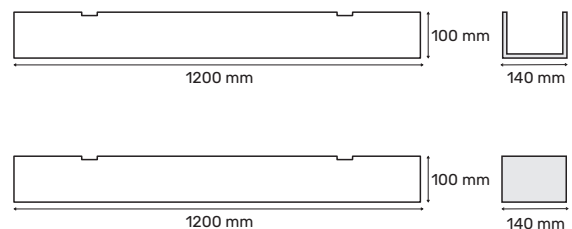

With the SilentTune_F version, the caps must be glued.

Examples of using SilentScape modules
in interior design



SilentLink



SilentLink

Examples of using SilentScape modules
in interior design



Examples of using SilentScape modules
in interior design



FlexiTone



FlexiTone

Examples of using SilentScape modules
in interior design



Examples of using SilentScape modules
in interior design



SilentTune



SilentTune

feltdecor[®]
s.line

More than silent

Authorized distributor:

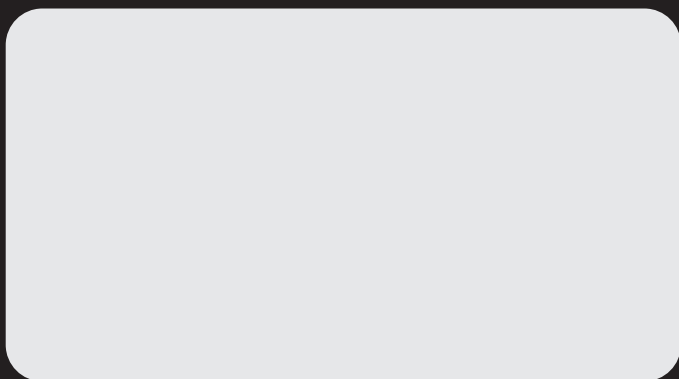

Edit 1/2026

www.feltdecor.eu